

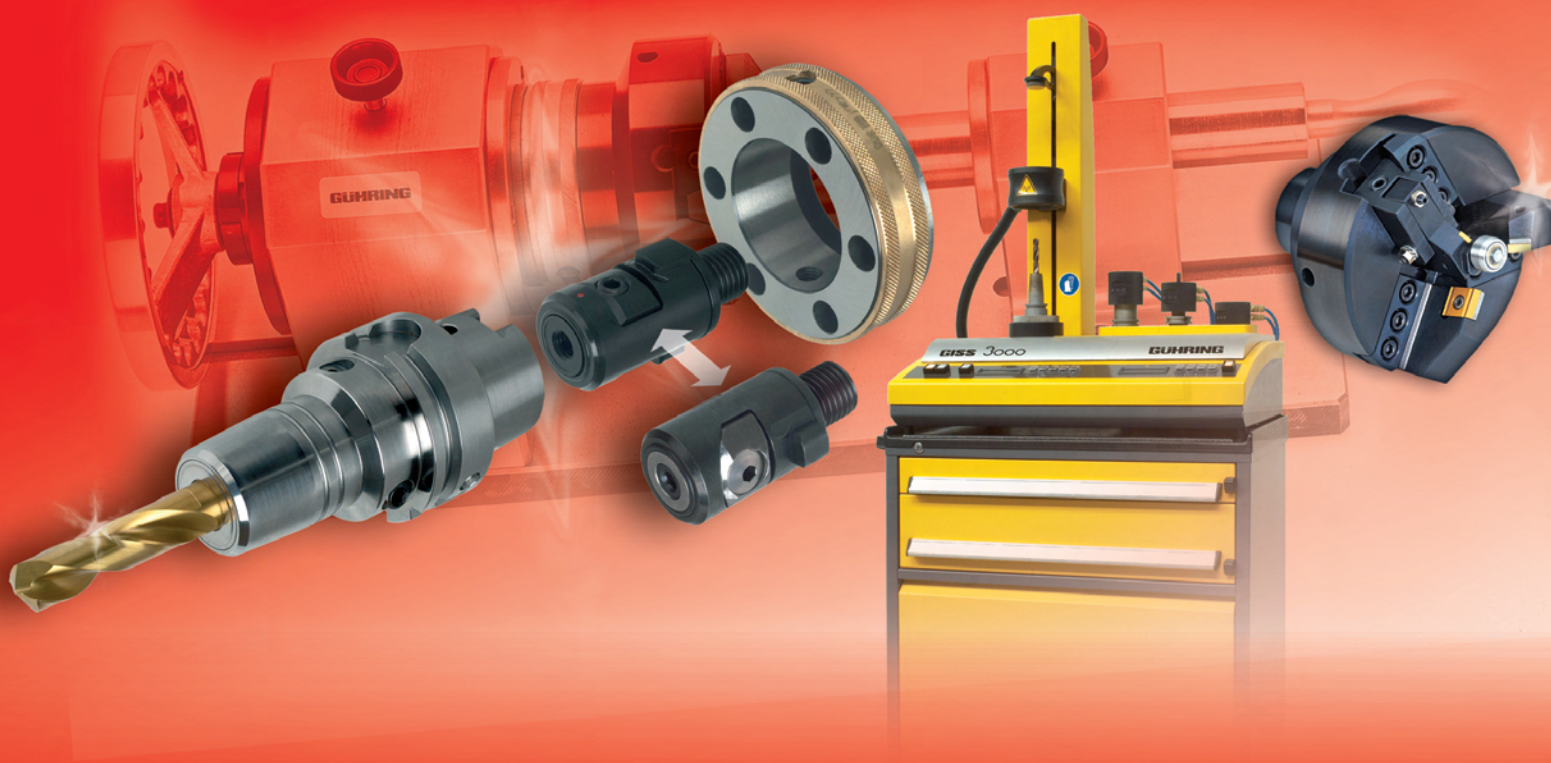

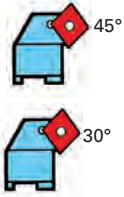







# MODULAR TOOLING SYSTEMS

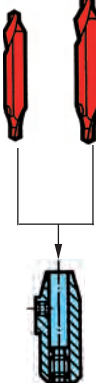

**GUHRING**

# System Summary GE 100

Tool holder, radially adjustable				Clamping sleeves to hold centre drills
for internal operations	for external operations	for turning operations	for facing operations	
	 <p>Angle adjustable 15° - 60°</p>  <p>45°</p>  <p>30°</p>	 <p>axial adjustable</p>		

Tool heads		
		
		
with 2 clamping holders	with 3 clamping holders	with 4 clamping holders

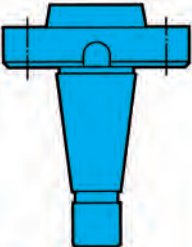
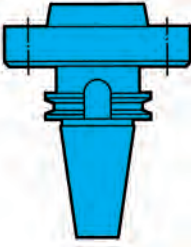
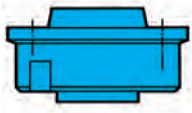
Adaptors		Adaptor
<p>with ISO taper to DIN 2080</p> 	<p>with ISO taper to DIN 69 871</p> 	<p>for UMA Ø 45/88,88*</p> 
* other systems on request		

**MQL 4-Point Clamping**



**Guhring no. Description**

4930	MQL 4-point clamping sets
4931	Clamping device for MQL 4-point clamping sets
4932	Ejector for MQL 4-point clamping sets
4933	Retention spindles for MQL 4-point clamping sets
4934	Adaptor for MQL 4-point clamping sets
4935	Retention screw for MQL 4-point clamping sets

**4-Point Clamping**

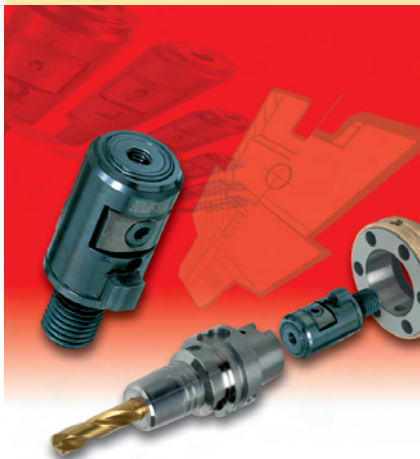

**Guhring no. Description**

4351	HSK-C extensions
4355	HSK-A/HSK-C reducing adaptors
4385	Short HSK spindle adaptor
4386	HSK spindle adaptor (in front)
4387	ISO taper/HSK-C basic adaptor on spindles to DIN 2079
4953	Brass sealing collars
4957	Components for 4-point clamping sets
4958	4-point clamping sets for conventional cooling
4959	Components for 4-point clamping sets
4961	Ball pressure screws
4963	Torque sockets

**PowerClamp**



**Guhring no. Description**

4509	ISO taper basic adaptors DIN 2080 form A/HSK-C
4510	VDI basic adaptors DIN 69880-1/HSK-C
4512	ISO taper basic adaptors DIN 69871 form AD/HSK-C
4514	MAS 403 BT/HSK-C basic adaptors
4549	HSK-A/HSK-C extensions
4551	Spring and threaded pin for PowerClamp set
4553	Aluminium locking rings
4554	PowerClamp sets
4555	Threaded spindle for PowerClamp set
4557	Tensioning nut set for PowerClamp set
4581	HSK adaptors (in front)
4582	HSK adaptors (in front) for turning centers
4584	HSK-C spindle adapters (integrated)
4586	HSK adaptors (in front)
4953	Brass sealing collars
4961	Ball pressure screws

**MQL Program**

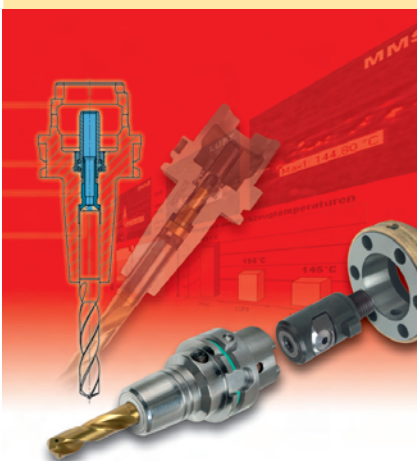

**Guhring no. Description**

4209	HSK-A MQL-Hydraulic-chucks
4210	HSK-A MQL-Hydraulic-chucks
4310	Collets for MQL
4330	MQL synchro tapping chuck
4350	HSK-A extensions with minimal lubrication
4735	MQL HSK-A shrink fit chucks
4741	MQL HSK-A shrink fit chucks
4919	MQL length pre-setting screws
4924	MQL coolant delivery sets
4939	MQL coolant delivery set HSK-A
4940	MQL filler HSK-A
4941	Length adjustment screw
4948	Montageadapter
4972	Montageadapter

**Hydraulic Chucks**



**Guhring no. Description**

4038	Clamping force measuring instrument Senso 3000
4099	Extraction key for reduction bushes
4213	ISO taper hydraulic chucks DIN 69871 with increased clamping force
4221	MAS/BT hydraulic chucks with increased clamping force
4267	HSK-C hydraulic chucks with increased clamping force
4295	HSK-C hydraulic chucks
4296	HSK-A hydraulic chucks with radial length pre-setting
4299	HSK-A hydraulic chucks with increased clamping force
4313	ISO taper hydraulic chucks DIN 69871
4315	Length pre-setting ISO taper adaptors
4316	Universal length pre-setting HSK adaptors
4319	Universal length pre-setting ISO taper adaptors
4321	MAS/BT hydraulic chucks
4367	HSK-C hydraulic chucks
4368	Reduction bushes for hydraulic chucks w/o peripheral cooling
4369	Reduction bushes für hydraulic chucks with peripheral cooling
4395	HSK-C hydraulic chucks with radial length pre-setting
4396	HSK-A hydraulic chucks with radial length pre-setting
4399	HSK-A hydraulic chucks
4900	Adjustment screws
4919	MQL length pre-setting screws
4992	Taper inserts
4993	Plug inserts

**Shrink Fit Technology**



**Guhring no. Description**

4718	Length pre-setting adaptor
4719	Shrink fit extensions
4720	Centering ring
4721	HSV 2000 hot air shrink fit system
4729	GUhroJet ISO taper shrink fit chucks DIN 69871 Form AD/B
4736	HSK-A shrink fit chucks
4737	HSK-E shrink fit chucks
4738	ISO taper shrink fit chucks DIN 69871 form AD/B
4739	MAS-BT shrink fit chucks
4742	GISS 2000 induction shrink fit system comfort version
4743	Induction spindle
4744	ISO taper holders
4745	HSK holders
4747	SpeedCooler
4748	Trolley
4749	Tongs
4750	Protective gloves
4751	GISS 2000 ECO
4752	GISS 2000 ECO Plus
4753	GISS 3000 induction shrink fit system
4755	Guhrojet HSK-A shrink fit system with peripheral cooling
4758	HSK-C shrink fit chucks
4759	SpeedCooler Manager
4769	Limit stop washers
4773	Cooling adaptor
4774	HSK-A/E accessory sets
4775	HSK-C accessory sets
4776	ISO taper accessory sets
4777	MAS BT accessory sets
4919	MQL length pre-setting screws
4977	Einstellschrauben mit Axialdämpfung

## Tool Holders



Guhring no.	Description
4206	Inserts for quick-change tapping chucks
4300	HSK-A precision clamping chucks
4301	SK-A precision clamping chucks
4302	Clamping sleeves for precision clamping chucks
4303	HSK-C collet holders
4304	HSK-A collet holders
4306	Retaining nuts, system DIN ISO 15488
4307	Collets to DIN ISO 15488
4308	Tapping collets
4317	ISO taper side lock holders
4318	ISO taper collet holders DIN 69871 form AD/B
4320	HSK-A Morse taper holders
4322	ISO taper side lock holders
4323	HSK-C collet holders, sealed version
4324	HSK-A collet holders, sealed version
4326	Synchro tapping chucks, straight shank
4327	Synchro tapping chucks, HSK-A
4328	Quick-change tapping chucks, HSK-A with IC
4329	HSK-A side lock holders
4333	HSK-C side lock holders
4334	HSK-A side lock holders
4335	Sealing washers
4340	Quick-change tapping chucks w/o IC
4342	Quick-change tapping chucks with IC
4343	HSK-A adaptors for tapping chucks
4346	HSK-A NC drilling chucks with IC
4361	HSK-A shell milling arbors
4362	Milling arbor HSK-A
4397	HSK-E collet holders
4901	Adjustment screws for HSK-C collet holders
4902	Adjustment screws for HSK-A/HSK-E collet holders
4903	Clamping screws
4904/4905	Adjustment screws
4906	Adjustment screws for tapping collets
4907	Screws DIN EN ISO 4762
4908	Milling cutter retaining screws DIN 6367
4909	Box spanner for retaining screws
4913	Chuck spanners
4922	Drive dog sets for shell milling arbors
4923	Keys DIN 6885 A
4982/4983	HSK-A/HSK-C blanks

## Measuring and Inspection Instruments General Accessories



Guhring no.	Description
4038	Senso 3000 clamping force measuring instrument
4068	Flow rate measuring instrument PQ 3000
4076	Coolant supply measuring instrument CC 3000
4077	High-grade steel filters
4910/4911	Socket spanners
4912	Hexagon chuck keys
4914	HSK cleaning mandrels
4915	Torque wrenches
4916	Sockets
4918	Cylindrical cleaning mandrels
4921	Hexagon-socket offset screw key
4925	Pull studs DIN 69872, form A
4926	Pull studs DIN 69872, form B
4927/4928	Pull studs
4946	Tool setting fixture
4947	HSK cleaning cap
4949	Coolant delivery sets for conventional cooling
4968	Gauges for HSK tool shanks
4969	Gauges for HSK spindles
4970	ISO taper proofing bars
4971	HSK proofing bars
4973	ISO taper clamping force measuring instrument
4974	HSK clamping force measuring instrument
4975	Balancing masters for HSK spindles
4976	Centrifugal rings for short spindles to DIN 69002-3
4978	Gauges for HSK cams
4985	HSK-C sealing plugs
4990	Tool setting fixtures
4991	Interchangeable discs

### Central Tool Management – around-the-clock

Guhring's TM Multi-Vend tool management system is a modular expandable automated system with electronically locked drawers for the storage of all types of tools. Thanks to the flexible composition of drawer heights and partitioning possibilities the TM Multi-Vend tool management system can be adapted to suit your specific requirements.

Operation with Guhring's TM software ensures a controlled storage and dispensing of the tools. Furthermore, the customer benefits from all evaluation and reporting possibilities of this intelligent software including the monitoring of minimum stock levels and automatic ordering.

Being an open system, the TM Multi-Vend tool management system is multiple supplier capable and, an ideal solution, not only for tool storage. Measuring and inspection instruments, assembly tools as well as expendable items can also be managed, stored and dispensed by this system to suit your needs.

### Guhring's Multi-Vend Tool Management System offers a considerable saving potential

- reduction in ordering costs thanks to online connection
- reduction in tool procurement/administration personnel requirements
- reduction in capital expense and stock value thanks to optimised stock control
- no machine downtimes thanks to permanent and reliable tool availability



#### One system - many possibilities:

Individual partitioning of the drawer heights to the customer configuration ensures that the TM Multi-Vend tool management system can be perfectly adapted to your storage requirements. Detailed information and dimensions can be found on page 7.

n

## Spiral insert for single dispense

With immediate effect a spiral module for single item dispensing is available for the TM Multi-Vend Tool Management System. The selected tool is dispensed via a separate drawer. This module offers 100 % dispensing control.

**NEW**



### The basic configuration of Guhring's TM Multi-Vend Tool Management System

- electronically lockable tool administration system of sturdy sheet steel construction
- full extension drawers (loading capacity per drawer max. 180 kg)
- individual partitioning material for drawers
- Guhring TM software with touch-screen and bar code reader
- online link to several suppliers possible
- interfaces to external WWS/ERP systems
- PC with Microsoft operating system
- system extendable through add-on modules



Tool withdrawal from the separate drawer

Lockable compartments

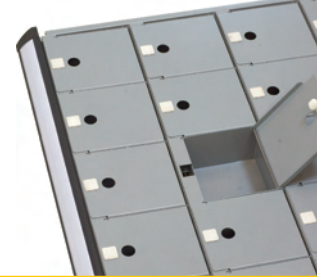

Anti-slip mat

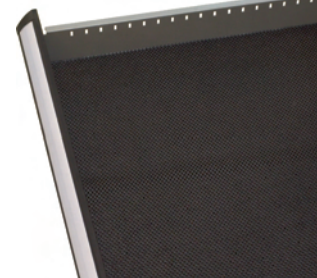

Recess sets



Compartment inserts



Partitions

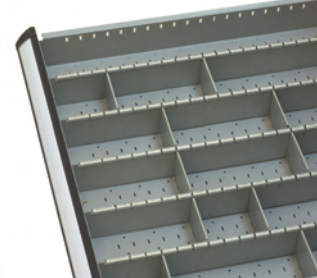

Various tool holders

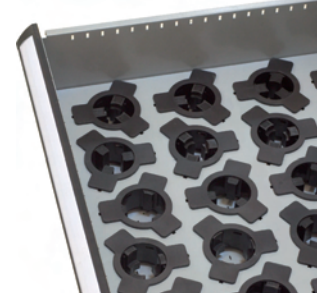



# GUHRING

## TM Multi-Vend Tool Management System advantages



**"A good service is important to us!"**



### Robert Koch GmbH, Trieringen

**"The TM Multi-Vend Tool Management System is the optimal entry-level solution for us to add to our existing tool cabinets"**

Robert Koch GmbH is a medium-sized company boasting a long tradition and specialising in the manufacture of highly accurate machined components. Tool storage was by conventional drawer cabinets, until the introduction of Guhring's TM Multi-Vend Tool Management System, however, without access and withdrawal control or a computer-assisted stock control.

Guhring's TM Multi-Vend Tool Management System is an intelligent addition to the existing tool cabinets. The tools continue to be stored in the existing tool cabinets but are managed via the TM Multi-Vend Tool Management System. The simple, but clever solution at Robert Koch: In the drawers with lockable storage compartments are not tools but keys to gain access to the conventional tool cabinets. The key withdrawal and return via Guhring's TM Multi-Vend Tool

Management System allows an indirect monitoring of the stock movement. Subsequently, only a small initial investment in a relatively small TM system was required to keep all the tools under control.

The advantages for Robert Koch GmbH are considerable: Robert Koch appreciates the savings made in tool ordering and tool searching to one hour per day. In addition, the 'dead' stock in the company has disappeared considerably reducing capital commitment. Instead, the system software provides accurate information regarding stock levels and order requirements. In total, Robert Koch estimates the saving is in excess of 10 percent.

# m - satisfied customers appreciate the

## AFS Fördertechnik GmbH, Mudenbach

**“The investment in the TM Multi-Vend Tool Management System should amortise within 5 years. We have reached this target in less than 3 years. Those who shy away from this investment only have themselves to blame!”**

Horst Bender, owner of AFS Fördertechnik GmbH, manages his tools and measuring equipment with Guhring's TM Multi-Vend Tool Management system. He particularly values the permanent overview of stocks and withdrawals. The latter information is special interest with the measuring equipment requiring calibration or adjustment after a certain number of applications - information, provided without problem by the TM Multi-Vend Tool Management system. The permanent stock control simplifies the planning and tool ordering considerably: “I now take stock in 5 minutes, not in a week! Lack of tools, manual lists, chasing etc. are now things of the past.”

**“Those who don't want to save, only have themselves to blame.”**

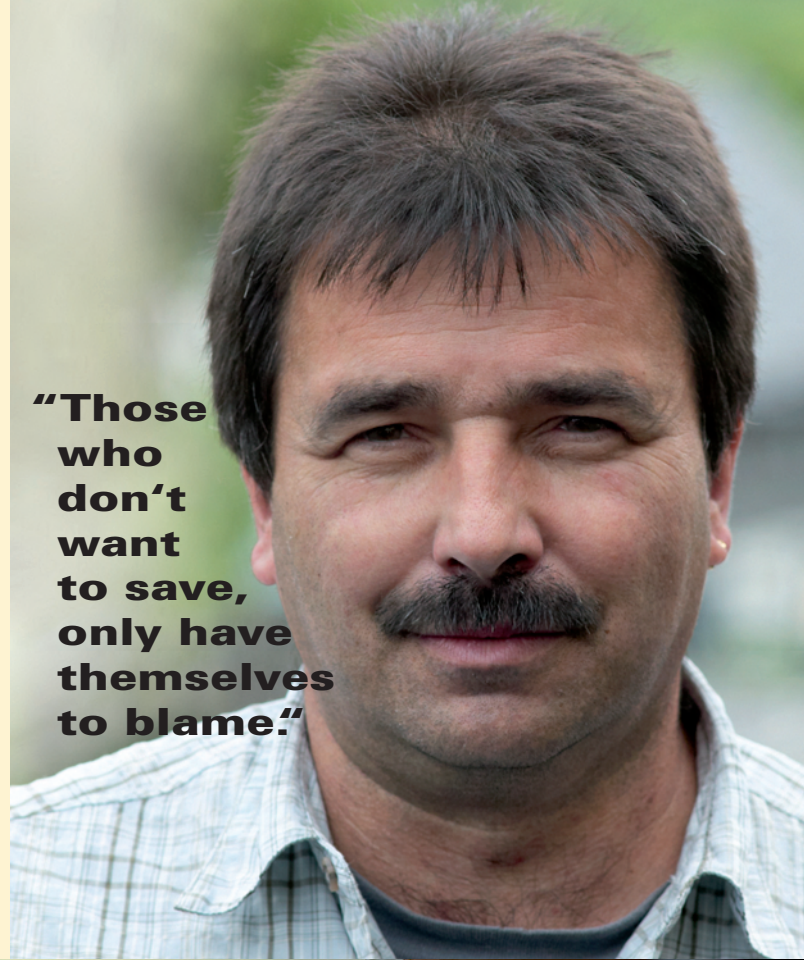

# TM Multi-Vend Tool Management System Designs and Dimensions

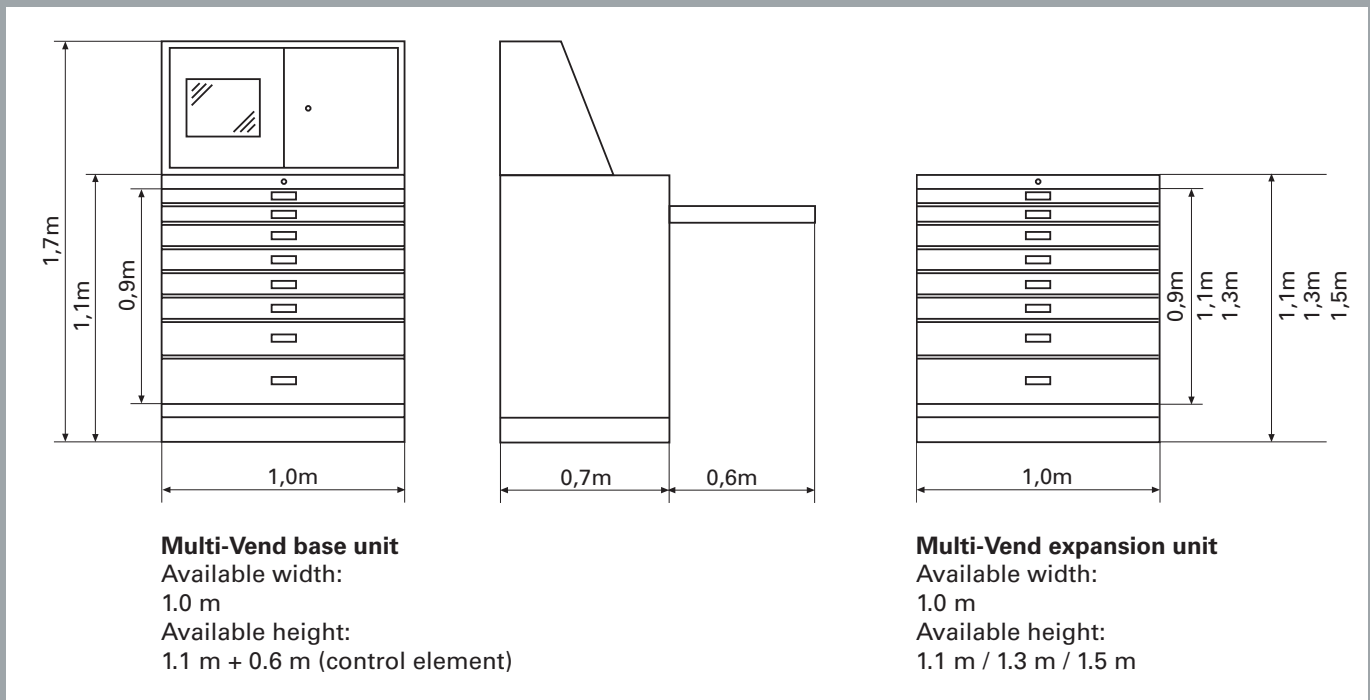

## Standard drawers

Heights: 75 mm / 100 mm / 125 mm / 150 mm  
 200 mm / 250 mm / 300 mm

Partitioning material (see also page 3):

- anti-slip mat
- recess sets
- compartment inserts
- partitions
- various tool holder systems

## Drawers with spiral insert

- drawer height: 150 mm
- spiral insert for a maximum of 10 spirals

additional requirement:

- withdrawal drawer with withdrawal shaft and 3 manually lockable compartments, drawer height: 150 mm

## Other

- forklift base with removable front panel
- operating voltage: 230 V / 50 Hz

## Drawers with electronically locked storage compartments

Available drawer heights:

- 75 mm (effective height 50 mm)
- 100 mm (effective height 75 mm)
- 150 mm (effective height 125 mm)

Compartments per drawer	Internal dimensions		Compartment layout	
	width	depth	width	depth
48	109 mm	75 mm	8	6
40	109 mm	95 mm	8	5
32	109 mm	125 mm	8	4
36	146 mm	75 mm	6	6
24	146 mm	125 mm	6	4
18	146 mm	175 mm	6	3
24	220 mm	75 mm	4	6
20	220 mm	95 mm	4	5
16	220 mm	125 mm	4	4
12	440 mm	75 mm	2	6
8	440 mm	125 mm	2	4

**GUHRING**  
TM Werkzeugausgabesystem ECO

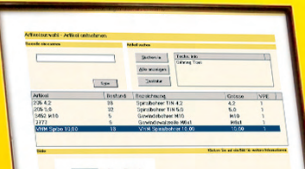

Artikel	Bestand	Bestandort	Größe	Stück
208 42	10	Spezialwerk T14 4.2	4.2	1
208 10	10	Spezialwerk T14 1.0	1.0	1
208 10.5	10	Spezialwerk T14 1.0	1.0	1
208 10.5	10	Spezialwerk T14 1.0	1.0	1
208 10.5	10	Spezialwerk T14 1.0	1.0	1



# Tool Management

Intelligent concepts to reduce costs  
in all aspects of Tool Management

- advice regarding the optimal Tool Management concept
- Tool Management to customer specific requirements
- hardware for optimised tool logistics
- software for Tool Management and production planning

**GUHRING**  
The Tool Company



### Why should you introduce your company to Tool Management?

**Dr. Steffen Lang, head of Guhring's service department, talks about Tool Management and its advantages.**

**? Dr. Lang, why should a manufacturing company become involved in Tool Management?**

! Whilst the direct tooling costs, that reflect tool consumption, are often known and the aim of optimisation, the indirect tooling costs are hidden in the process organisation of the tool administration. Subsequently, they are not as visible and quantifiable. Indirect tooling costs are, for example, procurement and storage costs, but also costs created by

the unavailability of tools, i.e. causing machine downtimes. Often the organisational shortcomings in a company are known but for different reasons the opportunities to introduce improvements are lacking. The required action would have to be carried out alongside the actual daily business and there is never enough time. Here is where we begin with our Tool Management concepts.

**? What are the consequences of these shortcomings?**

! To describe the possible consequences, I would very much like to quote from a case study!): 16% of all workflow interruptions can be attributed to a lack of tools. Foremen spend up to 60% and machine operators up to 20% of their time searching for tools and all this leads to the total machine availability being reduced by approximately 9%. Such organisational shortcomings and their repercussions we often come across - more or less strongly pronounced - in the companies. Optimisation can naturally remedy the situation. In this particular case the tool diversity could be reduced by 30% and the stock or work in progress respectively

could be reduced by 20% with an optimised Tool Management concept. Optimisation of the tools themselves reduced tool consumption by 15%. These and further measures resulted in a 5% increase in machine capacity utilisation.

### **Investments and process optimisations carelessly given away through inadequate organisation**

#### **? These are impressive figures. How does Guhring's Tool Management specifically help to exploit this potential?**

! One pre-requisite is that Guhring's Tool Management concept is a modular structured system. No customer has to buy system components from us that he doesn't really need or wants to outsource! The appropriate advice in close consultation with the customer is, therefore, very important to us. I have indeed already addressed the analysis of the manufacturing and process chain. Building on that, then follow suggestions for the outsourcing of processes and functions as well as for the application of our Tool Management soft- and hardware. At the end stands a Tool Management individually made-to-measure for the customer, optimally satisfying his wishes and requirements and entailing corresponding optimisations.

#### **? The described measures target the indirect tooling costs. But what does it look like for the direct tooling costs?**

! For optimising the tool consumption and therewith the direct tooling costs we engage experienced Guhring Tool Managers. Due to their expertise they can also optimise tools for technologies that are not part of Guhring's product portfolio such as, for example, honing or grinding tools. A further advantage is that Guhring tool Managers are not involved in the customer's day-to-day business. Thus you can concentrate 100% on optimising the tooling costs. Therefore, the optimisation targets are achieved in the shortest possible time.

## **Tool Management with Guhring is well worth it**

#### **? What further advantages does a Tool Management with Guhring exactly offer?**

! As Tool Manager, Guhring has at its disposal comprehensive experience and knowledge in the field of Tool Management through the successful processing of diverse projects. Furthermore, the customer receives from us important building blocks for a successful Tool Management from a single source: clear advice, operating a Tool Management project with the customer, a tried Tool Management software as well as automated tool dispensing systems and shrink fit systems. Dependent on the specific type of Tool Management project, the customer alone determines which tools he wants to acquire from Guhring. An example are projects where Guhring is responsible only for the procurement, stock-keeping and provisioning of the tools.

#### **? Many companies operate internationally. Can they also benefit from these advantages in their subsidiaries?**

! Guhring is a globally positioned company with its own sales companies as well as production and service centres on every continent. We are, therefore, in a position to offer our Tool Management concepts anywhere in the world – and indeed on the same high standard and with the same building blocks as in Germany. For example, we are currently successfully operating Tool Management projects in other European countries as well as in the Asia/Pacific region.

<sup>1)</sup> Sources:

- Ulf Müller: *Concept for the systematic planning and control of tooling in terms of an event oriented Tool-Management; page 2; ISBN 3-8322-2569-2; Shaker Verlag, 2004*
- VDI-Z 147 (2005), No. 3 - March
- *MaschinenMarkt, March 2005*

### Combined expertise world-wide

Guhring is one of the world's leading manufacturer and supplier of rotary cutting tools. In excess of 100 years know-how in tool manufacture as well as own expertise centres for the areas of tool development, tool materials and coatings enable us to again and again develop outstanding tool innovations. The central focus of these activities is always the customer and his desire for efficient, economical and practical tools.

As we see ourselves as the complete supplier for everything in matters metal cutting we offer our customers timely and market oriented services in matters tool application. Our service division provides service features from re-grinding to re-coating right up to complete Tool Management concepts as well as the necessary soft- and hardware for Tool Management and process planning.

### Our service centres

Re-grinding  
with or without  
re-coating  
world-wide to  
original Guhring  
quality!



- |   |                      |                 |                     |
|---|----------------------|-----------------|---------------------|
| 1 Germany<br><i>Albstadt<br/>Berlin<br/>Chemnitz<br/>Eisenach<br/>Geislingen<br/>Gosheim<br/>Mindelheim<br/>Saarbrücken</i> | 2 Australia          | 12 Korea        | 22 Taiwan           |
| 3 Brazil - Diadema  | 3 Brazil - Joinville | 13 Mexico       | 23 Thailand         |
| 4 Brazil - Joinville  | 5 China              | 14 Netherlands  | 24 Czech Republic   |
| 5 China   | 6 France             | 15 Austria      | 25 Turkey           |
| 6 France  | 7 Great Britain      | 16 Poland       | 26 Hungary          |
| 7 Great Britain   | 8 India              | 17 Rumania      | 27 USA - Brookfield |
| 8 India   | 9 Indonesia          | 18 Russia       | 28 USA - New Hudson |
| 9 Indonesia   | 10 Italy             | 19 Sweden       | 29 Vietnam          |
| 10 Italy  | 11 Japan             | 20 Spain        | 30 White Russia     |
|   |                      | 21 South Africa |                     |

**Advice**



**Customer**



**TM-  
project**



**Software**



**Hardware**



## Tool Management from Guhring – everything from a single source

Customers can get all the components to optimise their tool administration from a single source - from Guhring.

Our service begins with practical advice and support for optimising the customer's tool administration and leads via the required hardware (automated tool dispensing systems, GISS shrink fit systems) and software (Guhring Tool Management Software) to a part or complete management of the customer's tool administration.

The customer benefits from the advantages of having Guhring as a partner at his side that can support him in all aspects of tool administration. Thus, projects can develop step-by-step and are always accompanied by the same partner that knows the customer and that the customer knows.



**Solid advice is the basis of further optimisation steps for the customer's tool administration and logistics. Experienced Guhring Tool Managers provide both advice and practical support.**

With the advice concept, the central focus is on the indirect tooling costs. These can account for a considerable part of the actual existing tooling costs. As the direct tooling costs are hidden in the organisational processes, they are also often not apparent in contrast to the direct tooling costs. Thus, an evaluation of the consequences of an inadequately organised tool administration is not possible, whereby these can be serious and result in a production stoppage due to the non-availability of tools.

With an inadequately organised tool administration, cost savings in direct tooling cost achieved through technology and tool optimisation can be easily lost or not realised.

Amongst other things the following processes can be identified as the cause of indirect tooling costs:

- the order process including the order, order registration, accounting control and registration of invoices, payment etc.
- the engagement of personnel in the purchasing department, in the planning department, in tools inwards, in tool distribution, in tool allocation etc.
- the storage costs including interest on the stock, in particular tools not required very often.
- the inadequate transparency of the current stock level.
- incomplete information regarding the current tool consumption.
- the stock assessment and possible writing-off of tools not used frequently.





## Tooling costs per component on the basis of withdrawals

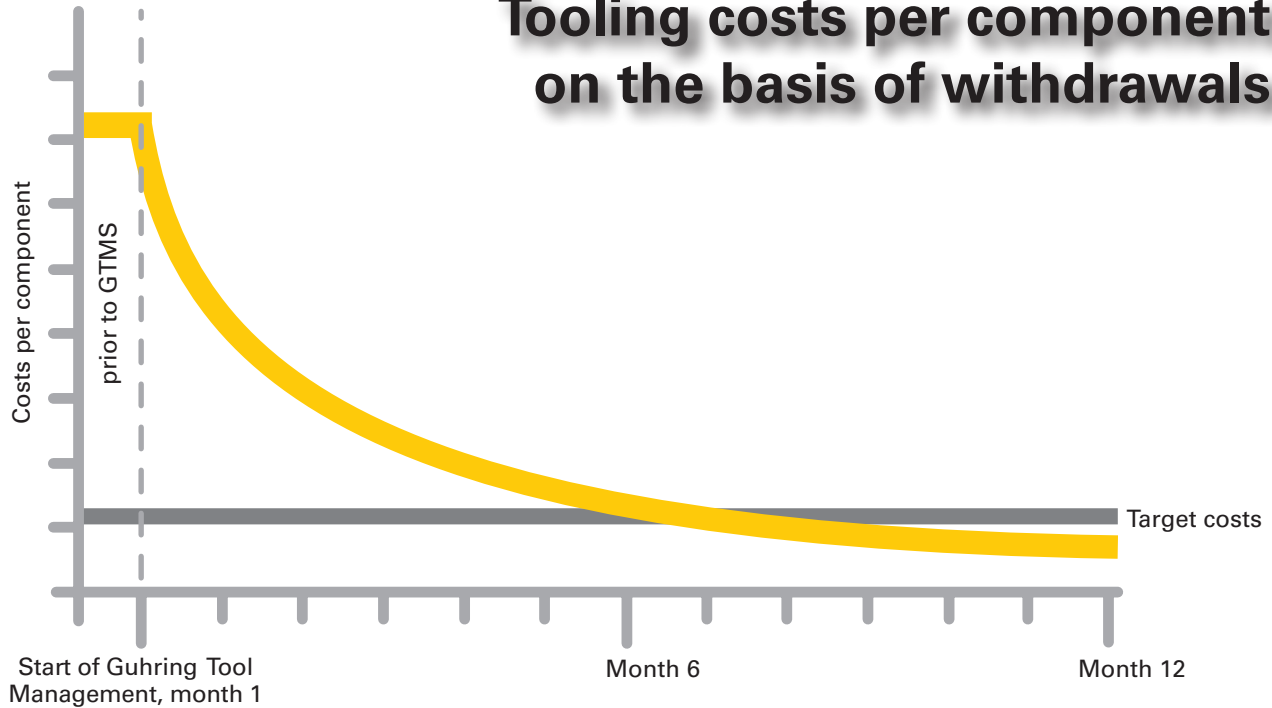

Together with the customer, Guhring Tool Managers analyse the complete tooling including tool cycle, process planning, tool storage and production areas. The aim is to gain as deep as possible insight into the processes of the customer's day-to-day business. How is the tool storage and the process planning organised? How does the tool cycle function in production? How does the disposition and ordering of tools work?

Therefore, not only tooling is in the focus of the consideration. We together with the customer carefully examine all the factors involved in the process.

Based on these analyses, the optimising solutions and the appropriate implementation concepts are determined. Thereby, we benefit from the experience gained from the Tool Management projects we carry out world-wide. Therefore, the Guhring Tool Managers are in a position to work out and present practical and relevant business improvement concepts to the customer.

The subsequent implementation of such improvement concepts requires additional work to be carried out by the participants alongside the actual day-to-day business. Because not every company is in a position to make these additional working hours available, we are able to support the customer on the premises with our experienced Tool Managers during the implementation. This guarantees that the optimisation measures are actually implemented

as soon as possible. Only measures actually implemented show results.

Aim of a joint advisory concept is to pinpoint the organisational weak points and the resulting starting points for optimisation and implement these together with the customer, so that he works with an optimised tool administration after project completion.

Guhring's Tool Management Service consists of five different service package moduls that the customer can assemble and combine flexibly, individually and made-to-measure according to customer's requirements.

The aim of Guhring's Tool Management Service is the

- technology awareness
- high quality
- within the time-frame
- cost-justified
- increased productivity

provision of all tools required in the customer's manufacturing process as well as relieving the customer's production and tooling of non-value adding tasks and services.

Utilise the expertise and benefits of Guhring's Tool Management Service, to increase the customer's efficiency and optimise tool logistics. Choose the building blocks required in the production and combine them to create a customer individual Tool Management package.

Two typical project models are a logistical and technological Tool Management.

## The 5 Tool Management columns

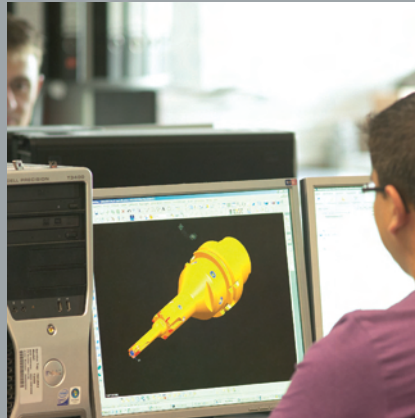

### Process planning

*Are you just setting-up a new production line?*

*Do you want to optimise the complete manufacturing process and apply intelligent tooling solutions?*

*Then Guhring's Tool Management Service will provide the following support:*

- tool layouts
- tool design
- technological parameters
- manufacturing documents
- planning the original equipment



### Logistics

*Prevent down-times through lack of or wrongly supplied tools and spare yourself unnecessary administrative costs of processing the tool order, delivery and storage.*

*To ensure the correct tool is at the machine at the right time, we also take over tasks in logistical matters:*

- determination of requirements
- planning and acquisition
- consignment stock
- incoming goods inspection
- warehouse management
- provision of new tools at the machine
- collection of worn tools at the machine
- tool vending machines and tool administration systems
- monthly invoicing

# every possible requirement



## Tool application

The actual tool application requires numerous operating steps that Guhring's Tool Management Service can relieve you from. Enabling you to concentrate on your core task: the machining of components. You can confidently leave the preparation of new tools and the maintenance of worn tools to us:

- stock withdrawal
- assembly and pre-setting
- disassembly
- evaluation
- despatch for refurbishment
- scrapping



## Tool maintenance

The evaluation of a worn tool has shown that it is worth refurbishing? An applied tool is to be optimised by modifications? These are also tasks for Guhring's Tool Management Service – including the accompanying logistics. Our service centres world-wide takeover the following services quickly and uncomplicated directly near you:

- tool collection
- de-coating
- re-grinding
- coating
- modifications
- tool delivery



## Process optimisation

Our offers as part of the process optimisation module predominantly target the optimisation of tools already applied in the customer's production. As a result, the customer can on the one hand reduce the range of tool options and therefore the stock-keeping, on the other increase the efficiency of the production. For this purpose, we offer the following services:

- ABC-analysis of the tool costs
- analysis of unstable processes
- plan of action
- target tracking

### Services ...

- provision of tools with consignment stock.
- the customer decides on the tools to be applied during the project term.
- Guhring is the main contact for all tools, including non-Guhring tools and turning, grinding and honing tools etc. including so-called C-products (i. e. assembly tools or inspection instruments).
- Guhring TM tool dispensing system for the storage of tools.
- monitoring the stock level with the customer.
- planning and ordering all tools to be applied including third party products.
- monitoring delivery dates.
- separate stocking of new and refurbished tools.
- collection of worn tools by the Guhring collection service.
- re-grinding and re-coating with original geometries and original coatings in Guhring service centres.
- delivery of new and refurbished tools, stocking Guhring's TM tool dispensing system.
- provision of withdrawal lists and tool movement journal, evaluation of tool costs in respect of new and refurbished tools.
- producing consumption analyses.
- monthly billing of tools dispensed by Guhring. Subcontractors are paid by Guhring.
- extending the project is possible at any time. The price for new tools to be added to the project is agreed with the customer.



### ... and customer advantages

- only a single contact for all tools and products.
- Guhring also supplies non-Guhring tools and so-called C-products.
- the customer can concentrate on his core competences and value adding activities.
- reducing tied-up capital through consignment stock.
- accessing the cost savings potential with indirect tooling costs.
- cost transparency through clear cost allocation and monthly consumption reports according to different criteria such as period, product, cost centre, tool type etc.
- 24 hour tool issue with partly un-manned shifts.
- customer specific composition of the scope of services.



### Services ...

- *Guhring responsible for the complete tooling.*
- *Guhring project team with Tool Managers, application engineers and pre-setters on the customer's premises.*
- *support for Guhring tools and third party products – also for turning, grinding, honing and assembly.*
- *planning and ordering all tools to be applied.*
- *monitoring the delivery dates.*
- *incoming goods inspection.*
- *administration of tool storage.*
- *assembly and pre-setting of tools.*
- *supply of pre-set tools direct to the production facilities.*
- *collection of worn tools from production.*
- *disassembly and evaluation of worn tools including wear analysis.*
- *despatch of tools for refurbishment, i.e. for re-grinding and re-coating.*
- *continuous technological optimisation of tools and processes (CIP).*
- *systematic registering of achieved actual tool life.*
- *comprehensive reporting, i.e. tooling costs per component, determining the cost drivers per workpiece, documentation of tool life development.*
- *monthly billing according to price per component.*



### ... and customer advantages

- *the customer can concentrate on his core competences and value-adding activities.*
- *quickly achieving the optimisation targets, as Guhring Tool Managers can dedicate 100% of their working time for optimisations.*
- *reducing the personnel costs in the area of tool administration.*
- *fixed tooling costs for the project term through fixed price per component*
- *reduction of tied-up capital, as tools remain the property of Guhring.*
- *accessing the cost reduction potential for indirect tooling costs.*
- *cost transparency through clear cost allocation and monthly consumption reports according to different criteria*
- *customer specific composition of the scope of services.*



**STOW**  
Palletenregal  
Max. Nutzlast: 1000 kg  
Max. Höhe: 12 m  
18 Schubweitereinheiten  
18 Schubweitereinheiten  
18 Schubweitereinheiten

**GÜHRING**  
TM WERKZEUGAUTOMAT

87



# **GUHRING**

## **Successful with Tool Management**



**“Guhring  
has unrivalled  
experience  
in Tool  
Management.”**



## **The correct tool always on hand**

**Erwin Aberl, divisional manager of Central Services and Global Investment Planning at Engel Austria GmbH in Schwertberg/austria, counts on Guhring's logistical Tool Management.**

**He has many good reasons for this.**

**? Mr. Aberl, you have placed the complete tool logistics for your production in the hands of Guhring, an external supplier. Were you not afraid to handover such important competences?**

! Naturally one is first of all sceptical and imagines all that could happen when externally allocating such an important strategic task. But following thorough examination of the offer, consideration of all advantages and disadvantages as well as a testing phase in our training workshop we were just absolutely convinced of Guhring's logistical Tool Management.

**? From your point of view what has improved since the introduction of the logistical Tool Management?**

! For us everything has become easier. For example, there is now only one point of contact, because Guhring also takes care of non-Guhring tools. In addition, we could considerably reduce the costs in the area of tool logistics. With the consignment stock costs incurred are only for actually applied tools, storage costs are beared by Guhring. The shorter paths save our employees time no longer having to look up a central tool dispensory, as they can withdraw the required tools from a locally positioned TM tool vending machine. Thus, we can now concentrate a hundred percent on our manufacturing expertise. The provision of tools no longer causes us any worries whatsoever.

**Engel Austria GmbH in Schwertberg/Austria is the world's largest manufacturer of injection moulding machines and one of the leading companies in plastics machinery manufacture.**

**The high degree of product specialisation requires a component part or small lot production that entails very complex tool logistics. Subsequently, a large variety of tools must be kept in stock, the stock turnover, however, is relatively low. The result is an immense capital commitment.**

**With Guhring's logistical Tool Management introduced in 2008 today covers in excess of 12,000 different tools.**



**? So cost was not the most important criteria for the decision?**

! I wouldn't put it quite like that. Only the introduction of the logistical Tool Management has opened our eyes in many areas regarding the actual costs. Let's stay with the example point of contact. At first glance this may have little to do with costs. But if you look at the consequences of ordering with several suppliers one inevitably also comes across the cost factor. And this is not insignificant once respective analyses have been conducted.

**? On what basis have you generated these analyses?**

! The introduction of logistical Tool Management in cooperation with Guhring already contains comprehensive analyses. This includes a look at procedures and processes for the tool procurement and provision as well as the quantitative and qualitative analysis of the tool requirement. Following the introduction of logistical Tool Management, for example, consumption reports and cost centre allocation always provide maximum and complete tooling transparency. The facts and figures are clear for all to see.

# GUHRING

## Successfull with Tool Management

? How have your employees reacted to this changeover?

! I would be lying, if at first there had not also been a certain scepticism. But the advantages of Tool Managements are simply convincing. Today, everybody is delighted with the new opportunities we have in our production thanks to the benefits provided by logistical Tool Management. The cost awareness of our employees has also changed. When taking a tool they now see the cost which leads to a entirely different appreciation. Some employees were often not aware that a special indexable insert costs € 70. Subsequently, at times it would be disposed of before the end of tool life. Today, this doesn't happen any more thanks to the new cost awareness.



**Guhring delivery service:  
automatically always the  
correct tools.**





### ? How does logistical Tool Management now actually work in your company?

! Visible signs of our Tool Management with Gühring are the ten TM tool dispensing systems in our production. They dispense all the tools around-the-clock and take them back again following use. Then we are regularly visited by an employee from Gühring to collect the worn tools and restock with new or refurbished tools respectively. The rest happens actually unseen in the background. The recording of withdrawals and returns, the herefrom resulting orders, the billing – all that happens over online networks between Gühring and our company. Thereby, it was absolutely essential to us that the Gühring system was integrated in our existing data network with SAP, Oracle and Coscom.

### ? How would you sum up the introduction of the logistical Tool Management?

! We are absolutely satisfied and benefit immensely from this changeover. We have a made-to-measure solution that suits us perfectly: Everything we need, no unnecessary ballast. Therefore, we are already thinking about expanding the system. Because we now have the tooling costs so well under control, we would also like to get to grips with other cost drivers with Gühring's Tool Management. I'm thinking in particular of measuring equipment, replacement parts and especially protective equipment such as hearing protection, gloves or protective goggles, where we have an enormous consumption.



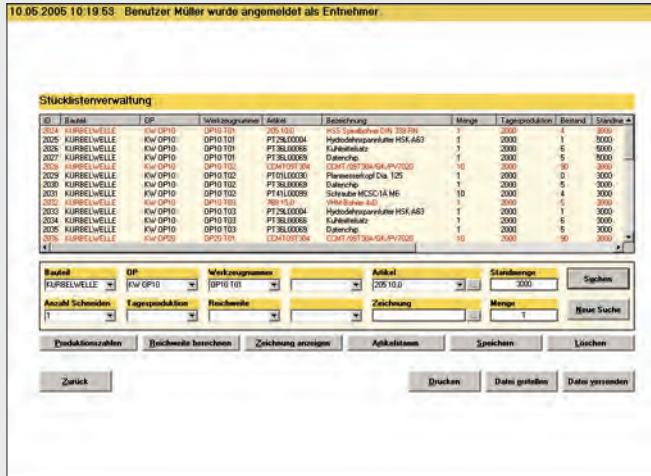

Stock list administration for producing new and for maintaining existing tool stock lists.

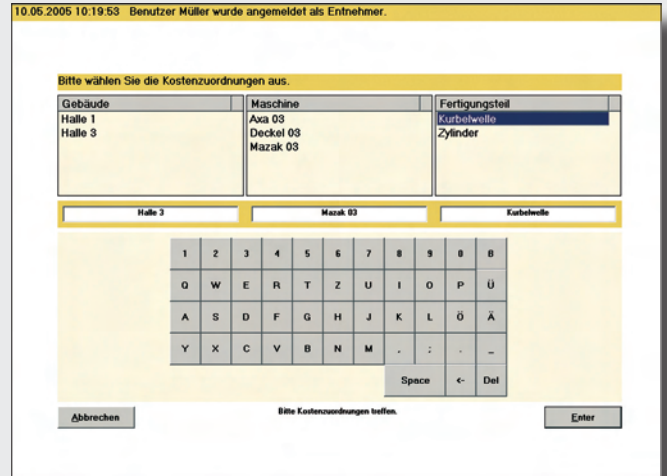

Allocating the withdrawn tools to different cost groupings.



Stock list print-out, displaying the required data to customer specifications.

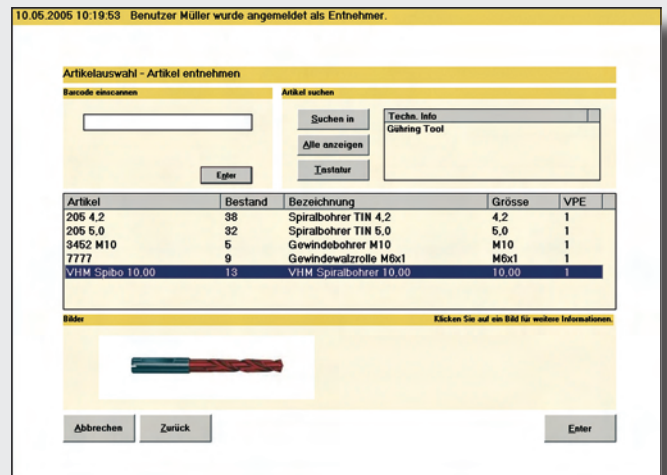

The tool selection is carried out to various criteria, i.e. item no., description or size.

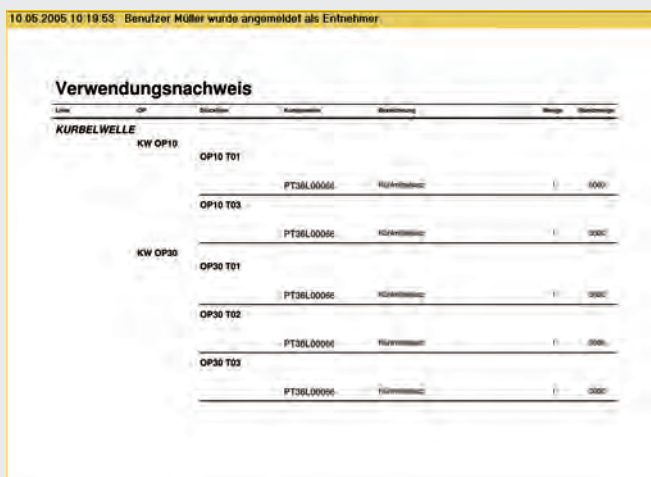

Usage list of the application of tools.

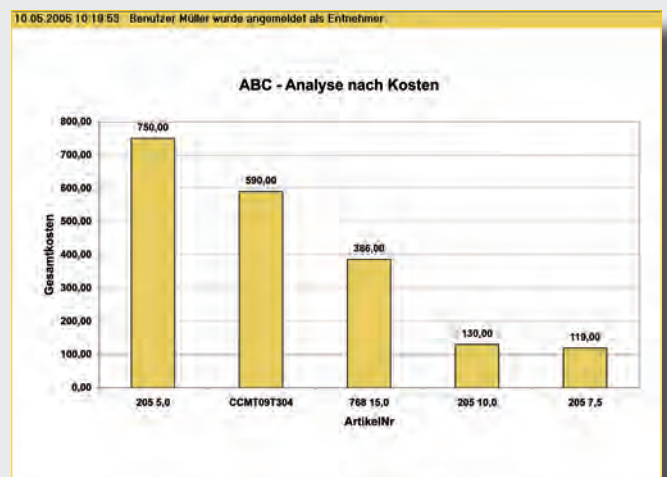

ABC-analyses for a detailed cost distribution



## Services and customer advantages

- producing tool stock lists.
- integrating electronic tool catalogues.
- direct call-up of CAD systems and graphics programs for processing and displaying of tool drawings.
- comprehensive warehouse management functionality which also controls the Guhring TM tool vending machines.
- three-level cost hierarchy for a clear cost allocation of tool withdrawals.
- exact consumption analyses to different criteria as, for example, tool consumption per component, per machine or per production area.
- the software already includes additional standard tools such as measuring equipment management, re-grinding management or ABC-analysis of consumption.
- individual solutions can be programmed according to customer request.
- simple, intuitive user guide.
- problem-free link to SAP, TDM, Coscom, IBM, ODBC, WebRFC etc. via respective interfaces.
- the software is available in German, English, French, Italian, Dutch, Polish, Danish, Hungarian, Czech, Spanish, Portuguese and Chinese (traditional).



# GUHRING

## TM Tool vending Machine and TM Multi-Vend

AFS Fördertechnik GmbH, Mudendach

**“The investment in TM Multi-Vend Tool Management system should amortise within 5 years. We have reached this target in less than 3 years. Those who shy away from this investment only have themselves to blame!”**

Horst Bender, owner of AFS Fördertechnik GmbH, manages his tools and measuring equipment with Guhring's TM Multi-Vend Tool Management system. He particularly values the permanent overview of stocks and withdrawals. The latter information is especially of interest with the measuring equipment, requiring readjustment after a certain number of applications - information, provided without problem by TM Multi-Vend Tool Management system. The permanent stock control simplifies the planning of orders and tool orders considerably: “I now take stock in 5 minutes, not in a week! And that tools aren't there at the beginning of a project although they're in my manually kept lists is also history.”

**“Those who don't want to save, only have themselves to blame!”**



# end Tool Management System



The controlled storage and dispensing of tools is the basis of maintaining the transparency of tool consumption and of the direct tooling costs. However, it requires that the tool stocks are kept under lock and key and that really every tool withdrawal is booked in the management software. This is the only way to ensure that the stock displayed is also physically present and that the tool planning can work reliably.

For the controlled storage and dispensing of the tools Guhring has at its disposal its Tool Management Systems TM Tool Vending Machine and TM Multi-Vend Tool Management System. Both excel thanks to simple operation, optimal storage possibilities as well as transparency of consumption and cost allocation. The systems are controlled directly via the Guhring Tool Management Software. Thus, all stock movements, including tool withdrawals can be booked directly into the central databank of Guhring's Tool Management Software and are available in real time for administrative procedures, i.e. tool planning.

When withdrawing tools the employee is forced by the running dialogue of Guhring's Tool Management Software to book in the tool withdrawal. If he doesn't end the dialogue correctly, the systems won't open and a tool withdrawal is not possible.

Subsequently, Guhring TM Tool Dispensing Systems offer all the decisive advantages of intelligent tool dispensing:

- **transparency of tool consumption, cost allocation and stock.**
- **24 hour controlled tool availability.**
- **preventing production downtime through monitoring the minimum stock level.**
- **sensitising personnel with regard to tooling costs.**
- **open system (multi-supplier capable).**





The best tool can't exploit its full performance if the basic conditions are not optimal. Therefore, Guhring have included the application of efficient shrink fit and pre-setting systems in their Tool Management offer.



### More than just shrink fitting: Guhring's GISS shrink fit systems:

Guhring's GISS shrink fit systems guarantee optimal tool clamping in shrink fit chucks. There is a choice of different models for shrink fitting tools for insertion or withdrawal depending on the specific requirements of the customer's production.

It includes high-tech solutions with integrated, highly accurate length setting as well as special shrink fit systems for extra length tools or multi-facet systems with different equipment options :

- **GISS 5000** for shrink fitting, setting and measuring including fully automatic cutting edge form recognition and length setting
- **GISS 3000** with automatic length setting
- **GISS 2500** for shrink fitting, setting and measuring.
- **GISS 2000** in different equipment packages, adapted to individual customer requirements.

ns





### **Gühring oHG**

Postfach 10 02 47 • 72423 Albstadt

Herderstr. 50-54 • 72458 Albstadt

Telefon: 07431/17-0

Fax Dienstleistung: 07431/93 31 36

[www.guehring.de](http://www.guehring.de)

# **GUHRING**

**The Tool Company**